

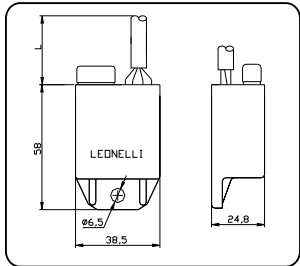

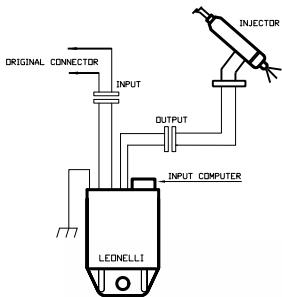

Limitación por tiempo de inyección / Limitation by injection time

Limitación por ángulo de encendido / Limitation by ignition angle

NEW

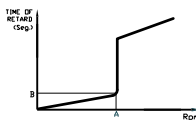
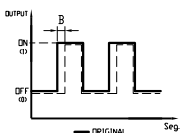
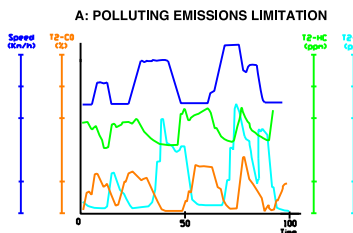
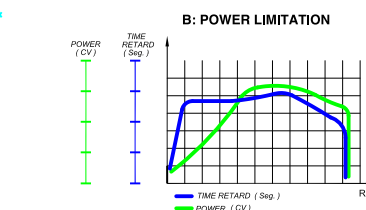
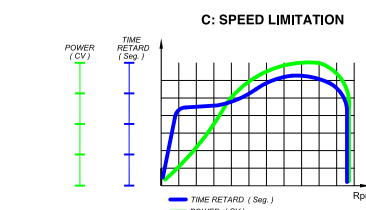
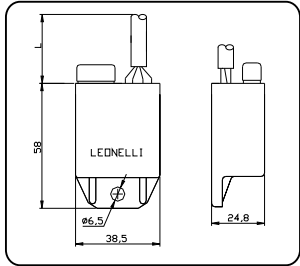
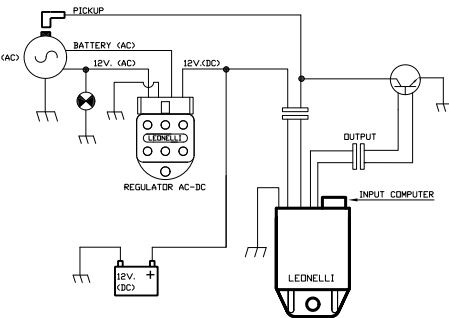

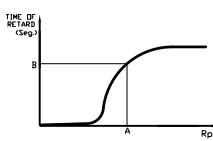
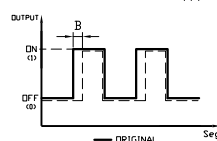
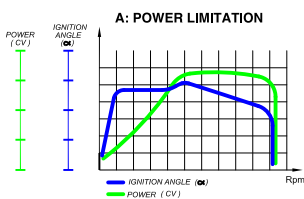
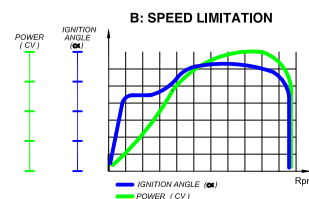
Consultar otras aplicaciones / Consult about other applications

Cambie los límites deseados del vehículo con el programador 928
Change the desired vehicle limits with 928 programmer

Unidades de control / Control units

Ref.: 355

Centrales intermitencia / Electronic flashing units

Mod. B

LED OPTION

Alterna basculante sin batería C.A. (10+10) W.
Balance without battery A.C. (10 + 10)W.

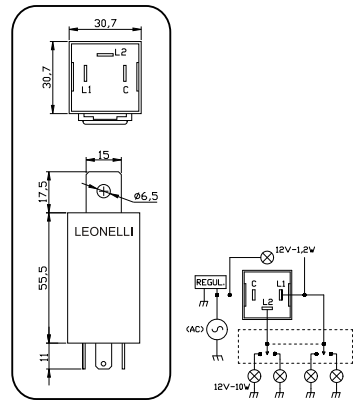

Mod. E

LED OPTION

Motocicletas C.C. (2 x 10) W.
Motorcycles D.C. (2 x 10) W.

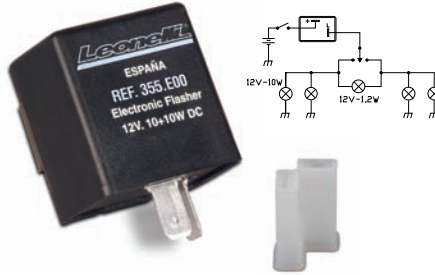

Mod. E1

Quads
C.C. (10 + 10) W. (4 x 10) W.
Atv D.C. (10 + 10) W. (4 x 10) W.

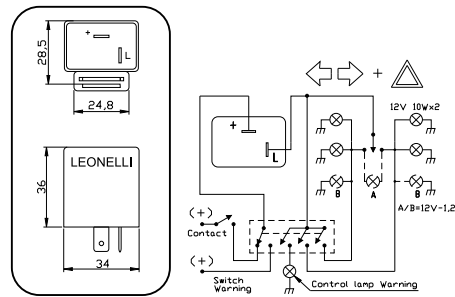

Mod. K Push Button

Con batería. Sistema de Memoria Warning
With battery. Warning memory system

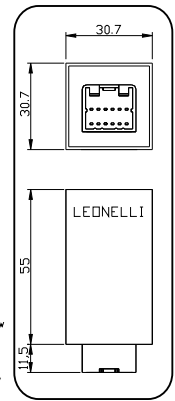

Mod. C

LED OPTION

Alterna sin batería C.A. 12V. 20W.
Without battery A.C. 12V. 20W.

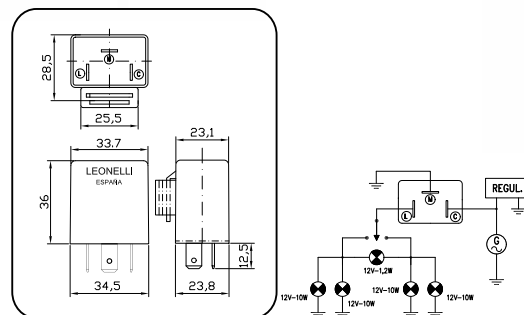

Mod. E6

Quads con remolque
C.C. 12V. 21W. (6x21W)
Atv with trailer D.C. 12V. 21W. (6x21W)



NEW

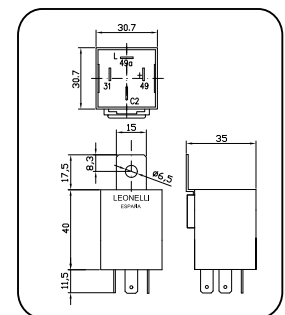
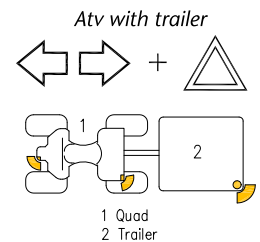

Soportes opcionales / Optional brackets. Con detección de fallo de lámpara / Lamp failure detection
Consultar otras versiones / Consult about other applications

Unidades de control / Control units

Controles digitales / Digital controls

Ref.: 038.D

Sistema dosificación / Dosage system

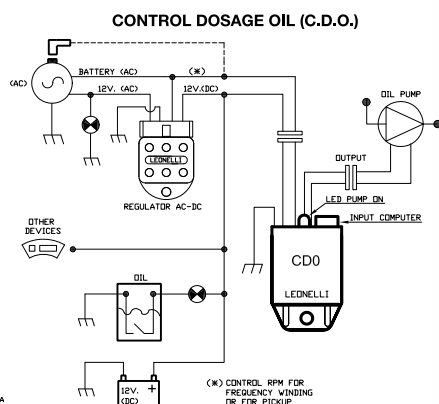
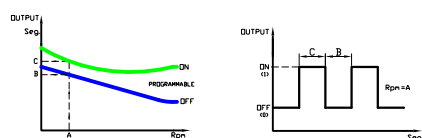
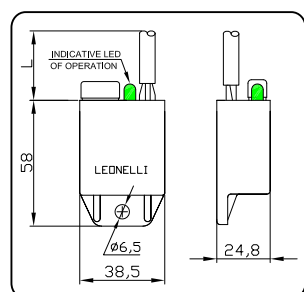

Ref.: 038.V

Convertidor Voltaje / Volt converter

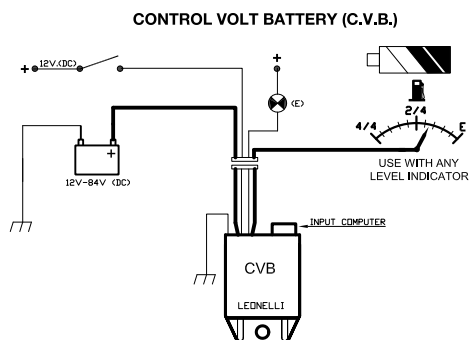
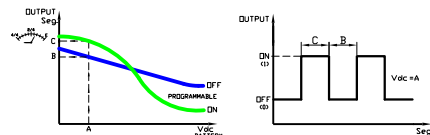
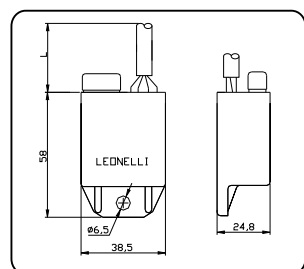

Ref.: 038.P

Sistema de accionamiento / Driving control

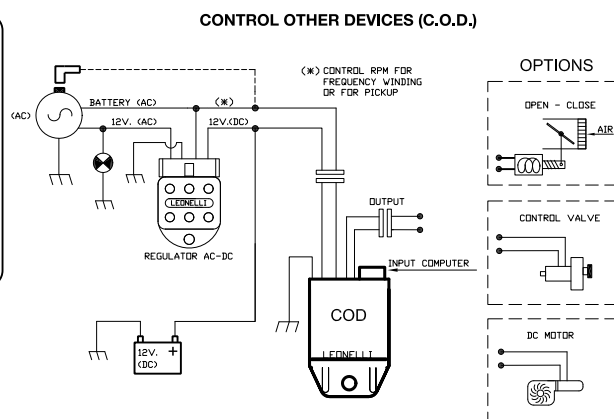
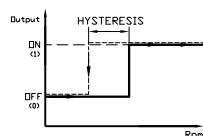
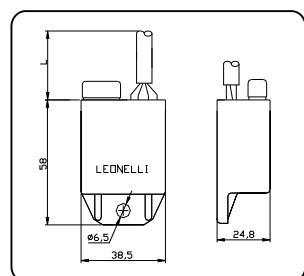

Consultar otras versiones / Consult about other applications